

ALUWEDO®

ALUMINUM COMPOSITE PANEL

A guide for
fabricators
and installers

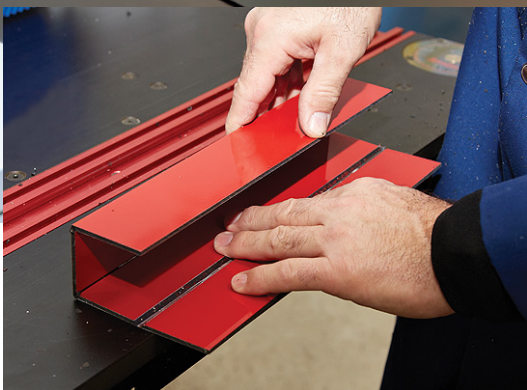



ALUWEDO®

ALUMINUM COMPOSITE PANEL

Product Description

Aluwedo® Aluminium Composite Panels consist of a polyethylene core faced with premium quality aluminium sheet on both sides. As a result of this technology, we have created a perfectly flat and very formable material with an excellent strength-to-weight ratio.

- Exceptional rigidity
- Outstanding strength to weight ratio
- Simple to fabricate
- Easy and quick to install
- High resistance to atmospheric conditions
- Easy to maintain

Aluwedo® Aluminium Composite Panels are supplied with a face PVDF, EVE and PE paint finish, available in the widest colour range on the market. The flexibility of the panel makes it a perfect material for sign makers, designers, architects, fabricators and installers.

This manual has been developed to assist fabricators and installers to work with Aluwedo® Aluminium Composite Panels in the most efficient manner possible. The following recommendations and product data are based on information which is, in our opinion, reliable.

However, since skill, judgment, and quality of equipment and tools are involved, and since conditions and methods of using Aluminium Composite

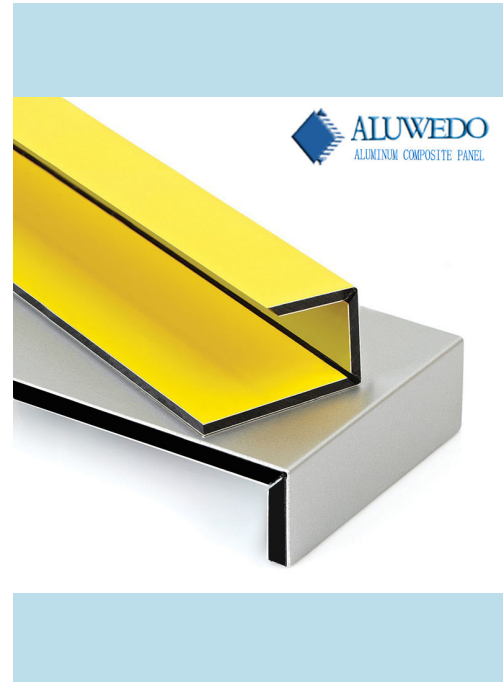

Panels are beyond our control, the suggestions contained in this manual are provided without guarantee. We recommend that prospective users determine the suitability of both the material and recommendations before adopting them on a commercial scale. In no event shall Siko Industry Ltd, have any liability in any way related to or arising out of said suggestions and product data for direct, special, consequential or any other damages of any kind.



Safety, Storage & Handling

Safety

Standard health and safety precautions should be adhered to when fabricating Aluwedo® Aluminium Composite Panel material. Goggles or other face protection, as well as hearing protection and gloves should always be worn. An MSDS for Aluminium Composite Panel is available from your local sales representative or distributor.

Packaging

Aluwedo® Aluminium Composite Panels come as standard with a clear protective film, designed to be removed just before installation to offer protection from surface damage.

Although the protective film is UV stabilised, it should be removed as soon as possible after installation, especially in the case of panels exposed to sunlight and adverse weather.

Handling

Aluwedo® Aluminium Composite Panels should be handled with care, especially when dealing with long lengths. It is advisable that a small team carry out the handling.

When removing panels from a pallet / stack never drag the panel, always lift clear above the remaining panels on the stack. This will require two or more operatives.

Storage

When storing unpacked Aluwedo® Aluminium Composite Panels please observe the following guidelines:

- To prevent warping or bending, store horizontally.
- Avoid stacking Aluminium Composite Panels of different sizes together, as the surface or panel can be damaged by the edges of the smaller pieces.
- Preferably, store them by size in racks.
- If storing panels vertically by leaning them against a rack, lay a rubber mat underneath and lean the Aluminium Composite Panel closely against the fixed back.
- Aluminium Composite Panels are packed in wooden crates and can usually be stacked up to five crates high.
- It is advisable to store Aluminium Composite Panels in a clean dry area with a minimum temperature of 15°C for a duration of 24 hours before use. After 24 hours of storage you will be able to start the processing requirements for each panel. After an Aluminium Composite Panel has been removed from the stack it must be protected from any penetrating moisture.

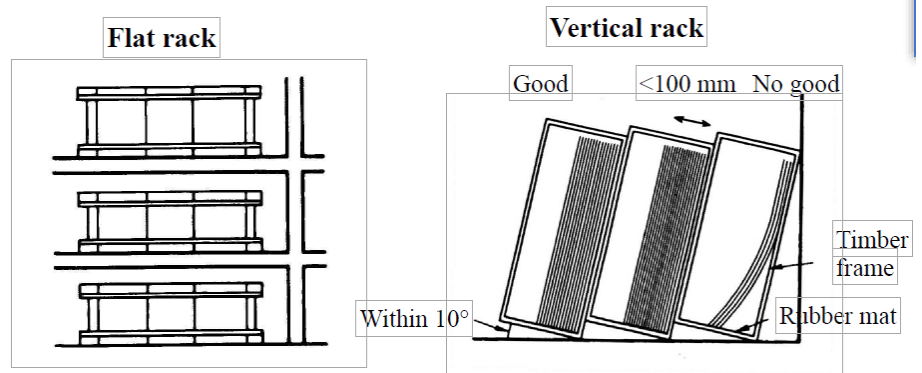



ALUWEDO®

ALUMINUM COMPOSITE PANEL

Visual Consistency & Sawing

Visual consistency

Each of our product types has special characteristics that can affect the visual consistency from batch to batch and even from panel to panel. It is important that these characteristics be considered when planning how to use and install Aluwedo® Aluminium Composite Panel.

Solid colours

The industry standard for allowable variation for panel to panel and batch to batch is Delta E 1.0 or less in a hunter colour space. Brighter colours, such as reds, yellows, blues, etc, which tend to be less opaque and which depend somewhat on film build (paint thickness) to achieve their appearance, will be more likely to exhibit more variation than subdued colours.

Projects - same batch

Metallic colours:

The industry standard for colour variation with metallic is Delta E 2.5 or less, much larger than the standard for solid colours.

Directional project:

In coating the flakes will tend to align in one direction. This greatly increases the directionality of the panel's appearance.

Production Batches/Projects: When working on projects it is highly recommended that material from the same production batch is used in order to maintain overall visual consistency. For these reasons the panels must be installed with the directional arrows all aligned in the

same direction. Batches should not be mixed on a building face without first contacting Siko Industry Limited for a confirmation that they are visually similar enough to be used together.

Before fabrication, remember to use a felt tip pen to draw arrows to indicate the coating direction on any small pieces that might be cut out from areas without the directional arrows.

Sawing





Sawing Aluwedo® Aluminium Composite Panels is an easy process that can be done with ordinary commercial metal and woodworking equipment.

Saw blades and router bits are available through independent distributors who handle cutting tools. Prior to processing large quantities, trial saw cuttings should be done to evaluate both the tool working conditions and the recommended cutting speeds. For marking the panels the use of a soft pencil is adequate. Hard marking tools should be avoided as they can fracture the aluminium surface. It is recommended that the swarf formed during cutting should be vacuumed away with compressed air.

Due to the nature of the Aluminium Composite Panels it is best to move the saw blade rather than the material as no scratch will remain on the panel. If good saw cutting practices are applied and recommendations followed, the result should be clean cuts with little bur. If despite following the recommendations, ragged cuts

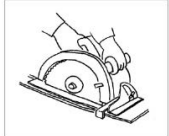
are produced check the following causes; poor tool support tool vibration blunt cutting edges high frictional heat at the cutting edge

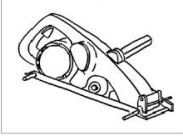
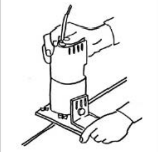
As Aluminium Composite Panels have low thermal conductivity they cannot be cooled easily with compressed air or any other means. Therefore it is recommended to select the tool geometry and cutting conditions in such a manner so as to minimize the frictional forces developed at the cutting point and keep the resulting heat at a low level.

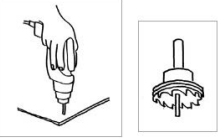
1. Table saw 	2. Hand circular saw 
3. Hand router 	4. Hand jigsaw 
5. Grooving machine 	6. Hand trimmer 
7. Plane 	8. Hand drill 

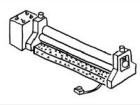
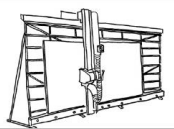
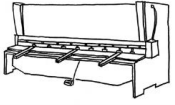
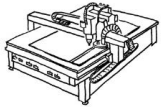
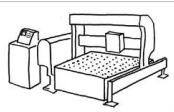
11. Press brake 	12. 3-roll bender 	13. Panel saw 	14. Square shear 	15. CNC router 	16. Turret puncher 
--	--	--	--	---	---



ALUWEDO[®]
ALUMINUM COMPOSITE PANEL

Saw Equipment

Saw cutting can be accomplished with the following equipment

Panel Saws

Panel saws provide an effective method of cutting. These saws, whether standard equipment or custom made, perform well and have the added advantage of space saving. If a panel saw is to be used as production equipment, an industrial model should be purchased in order to obtain adequate cutting tolerances and increase the longevity of the equipment.

Table Saws

Table saws are not recommended for large sheets.

Multiple Operation Rip/V-Grooving Saws

In high production operations, equipment that is capable of performing more than one operation with a single pass through the machinery is recommended.

This equipment can make multiple saw cuts (sizing the panel) and v-grooves (rout) at the same time.

Portable Circular Saws

Cutting Aluwedo[®] Aluminium Composite Panels with portable circular saws is another effective method. As mentioned, this equipment should also be production/ industrial standard equipment.

Jig Saws

Jig saws work well for cut-outs. Care should be taken with portable jig saws to prevent damage to the Aluminium Composite Panel material surface. More than one sheet can be cut at a time by stacking panels.

If centre cutting (i.e. letter cut-outs) is required, a foam pad may be placed under the material with the blade cutting into the foam. The sheets may be clamped or secured with double-sided tape for the cutting operation. When clamping between jaws, protect the panel surface against damage.

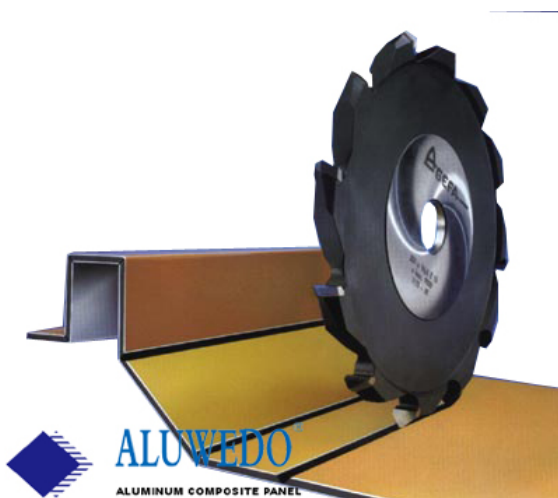



ALUWEDO®

ALUMINUM COMPOSITE PANEL

Routing & Folding

Aluwedo® Aluminium Composite Panels can be routed using conventional routing machines. For accurate and precise manual folding of the Aluminium Composite Panels, resulting in a good finish, we recommend to route the rear of the panels to a depth of 2.5mm thick, going through the exterior aluminium layer, and some of the polyethylene core. Normally the panel is grooved and folded 25-70mm from the edge.



In order to route Aluwedo® Aluminium Composite Panels the following equipment is necessary:

Vertical Panel Saw

Equipped with specially shaped routing saw blades. The equipment needed is the same vertical saw as the one used for the cutting, but with a different saw blade and relevant equipment for adjusting the routing thickness

Portable circular saw

A portable circular saw equipped with a suitable routing disk can be used, but only for a limited amount of processes. Note that special care should be given to the stability of the portable circular saw during processing of the material, as well as the precision of the routings with the help of the chosen guided system.

Hand operated router

These tools consist of routers that are commonly available on the market and are used for wood processing. If they are equipped with special routing bits (carbide tipped cutter) the hand operated router can be used for a limited number of processes. In this case the stability of the tool and the guide-system considerably affect the quality of the routing.

Work directions

For shaped elements with a radius of between 2-7mm proceed as follows:

- *The shape of the groove and its respective depth determines the folding radius. Note that smooth bending (shape forming of elements) cannot be obtained without uniform thickness of polyethylene remaining.*

Carbide Saw

By routing on just one of the sides of an Aluminium Composite Panel, it can be bent upwards or downwards to create both an inside or outside corner. When a groove is bent at a 90° angle the bending radius of the final product will be 3-3.5mm and the element will elongate by 0.5-1.0mm. As such, the original panels should be cut shorter by that proportion.

Grooving equipment

For processing a small number of panels a manual router with a v-groove blade and trimmer can be used. For processing large volumes a table circular saw/CNC router and a grooving cutter are needed along with a lifter.

The use of a chip collector is essential.

Technical characteristics of carbide saw-tip:

Outside diameter: **305**
No of the teeth: **24**
RPM: **3000 to 5000**



ALUWEDO®

ALUMINUM COMPOSITE PANEL

Corner Cutting & Bending

Two methods are normally used for cutting out corners to allow the forming of a cassette.

Wood chisel

A sharp hammer blow to a wood chisel allows you to cut out the small thickness at the bottom of a routing groove with no difficulty. The wood chisel must be wider than the part to be cut out.

With a little experience, good clean joints can be easily achieved.

Punching

This technique is the most productive, with the corners being cut out and the corner fastening holes being achieved in a single operation.



The minimum bending radius for Aluwedo® Aluminium Composite Panels without routing the back skin is forty times the thickness of the panel being curved i.e., 4 mm = 160 mm minimum radius. Aluminium Composite Panels can be cold formed in a pyramid roller, a press brake or over a clamped pipe. The process is similar to the forming of aluminium; however, due to the sensitive surface, care should be taken to ensure rollers are clean, smooth and free of defects to avoid damage to the surface.

Pyramid Roller

This technique is the most productive, with the corners being cut out and the corner fastening holes being achieved in a single operation.

Press Brake

When forming with a press brake, use a top die (tubular) with the radius desired and open the bottom die (jaws) approximately two times the thickness of the material plus film wider than the top die. The lower die should always have a protective pad of not less than 3mm film.

Some adjustment of the lower jaws may be necessary to allow for varying bending properties between anodized and painted finish and for varying thicknesses. The radius of the top die will be the approximate inside radius of the finished panel.

Bending Over a Clamped Pipe

Aluminium Composite Panels may be formed over a pipe of the proper diameter that is securely clamped to a work table. A hinged 'leaf' attached to the end of the table will bend the material easily.

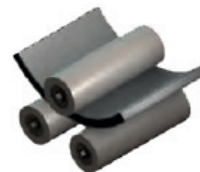

Pyramid Roller



Press Brake



Joining Techniques 1

Please find below some important general information about joining techniques. Use the following guidelines when other elements come in direct contact with the surface of Aluwedo® Aluminium Composite Panel material.



Drilling

Aluwedo® Aluminium Composite Panels can be drilled with standard drills used for aluminium and plastics.

Working Specifications

Drill bit: Twist drill, high speed steel.
Tip Angle: 100° - 140°, or counter-bore grind with centring tip.
Cutting speed: 164 RPM to 984 RPM.

Quick removal of chips can be achieved by a high RPM, slow feed speed and occasional lifting of the bit.

Joining

A variety of different fasteners are used to fabricate and install Aluminium Composite Panels. Structural adequacy and selection of these fasteners are the responsibility of qualified engineers and in most instances where architectural panels are used, certified calculations will be required by the Building Official. You may successfully use specific fasteners for panel load testing purposes in obtaining building code recognition.

Acceptable joining materials

Aluminium, plastic, stainless steel, plated or coated steel with cadmium, zinc or aluminium.

Unacceptable joining materials

Copper, brass, bronze, iron, raw steel. Unacceptable materials cause corrosion of joining surfaces due to electrolysis of dissimilar materials. Therefore, use 'heavy' or 'red' metals only with an electrically insulating intermediate layer.

When joining elements are to be anodized, assemble the materials after the anodizing process. Proper consideration should be given to the thermal expansion characteristics of the material when using any of the joining techniques.

Pop rivets are often used to attach aluminium clip angles and other structural or ornamental elements to Aluminium Composite Panels. Because the rivet body will be in contact with the aluminium skin of the panel, it is recommended that either aluminium or stainless steel rivets be used to avoid dissimilar metals contacting. Ultimate shear and tensile strengths of various rivets are available from the rivet manufacturer.

Please be advised that some building code jurisdictions do not endorse the use of pop rivets for structural connections.



Joining Techniques 2

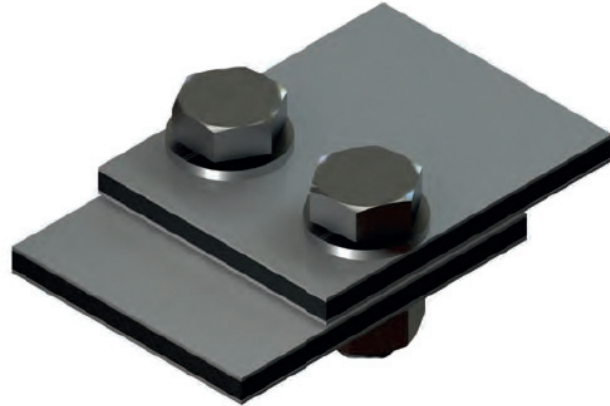

Screws

Screws are also used to perform many of the same applications as rivets. Stainless steel screws are industry standard and are appropriate to avoid corrosion and dissimilar metal contact. Because screws are customarily installed through pre-drilled holes it is recommended that sheet metal screw thread type fasteners be used, especially when the screw is under tension load and this load is resisted by the aluminium skins.

Occasionally, Aluwedo® Aluminium Composite Panels are face fastened directly to supports or sub-grids. The type and thickness of the support metal, as well as the applied load, will dictate the size and thread type of the correct fastener.

Through bolts:

These provide an excellent way to join sheets of Aluminium Composite Panels together, or to other elements. Galvanized, stainless steel or aluminium bolts, nuts and washers should be used to avoid dissimilar metal contact.

Caution is recommended in tightening the nut onto the bolt. Because the plastic core material is compressible, over tightening can deform the metal skins. Use lock nuts or double nuts with washers to prevent the nut from loosening over time.

Testing is advisable to determine the performance of any fastening system.



Joining Techniques 3

Welding

This method is frequently used to assemble Aluwedo® Aluminium Composite Panels. The filler rod and the polyethylene core are welded together after heating by a jet of hot air projected by an electrically heated welding gun.

For good quality welding, you will need:

- Good preparation of the edges to be welded together
- Adequate filler rod quality
- A good welding speed
- Evenly applied pressure
- Clean hot air
- An appropriate temperature

Welding by the to-and-fro method

Hold the filler rod at a right angle whilst exerting regular pressure on the rod, make to-and-fro B-B (non circular) movements. The filler rod and the edges to be welded must be heated in a similar way.

Welding using a high-speed nozzle

Normal hot air guns fitted with a removable high-speed welding nozzle allow the edges to be welded and the filler rod to be heated at the same time. This makes for better quality welding. The filler rod is pushed by the constant pressure of the high-speed nozzle, and is therefore pressed between the edges to be welded.

The polyethylene core oxidizes relatively quickly once exposed to the air. It must be welded within 24 hours max after it is bevelled. Once it has cooled, it is possible to remove the welding flash using a knife or scraper. We recommend that this operation be carried out in a clean, oil and water-free area.

Preparation of the edges to be welded:

Butt welding: The edges must be bevelled,

Corner assembly: Only one of the panels is bevelled.

T-assembly: Remove the narrow strip of metal skin to free the areas to be welded.

Welding of a fold: Bevel the edges to be welded first of all using a shaped milling cutter

The specific welding qualities of the filler rod are:

Polyethylene: Low density

Diameter of rod: 3, 4 and 5mm

Immediately before welding, remove the outer layer of oxide from the filler rod.

Adhesive Bonding

In addition to structural adhesives, double sided tape can be used for fixing panels on flat surfaces such as walls, ceilings, furniture, coverings etc. Extreme care should be given when selecting the adhesive so as to ensure it is chosen according to the application and the environmental conditions.

**Non shrink on Drying is essential.*

It is important that the manufacturer is consulted prior to the usage of the adhesive for further instructions.

The substrate surface should be clean before the application of the structural adhesive.



ALUWEDO®

ALUMINUM COMPOSITE PANEL

Coating / Printing / Cleaning / Film 1

Protective Film

The protective film ensures no residue is left on the panel, reducing cleaning time and eliminating the risk of interference with the print. An ultra white surface helps to display printed colours with increased brightness and intensity, with a special coating also delivering vastly improved ink adhesion for colour fast prints. Developed for the print market, Aluwedo® Aluminium Composite Panel ultra white is suitable for use both indoors and out and, is available with the reverse side milled and covered with transparent digital lacquer providing perfect adhesion for prints, achieving an amazing look of aluminium surface with colourful prints.

Off-line Coating

Aluwedo® Aluminium Composite Panels can be coated off-line if necessary. It is advisable to follow instructions as specified by the manufacturer of any paints to be used. **For off-line coating observe the following guidelines:**

- Surface should be lightly abraded to provide a better coating surface. The surface should then be cleaned of all contaminants i.e. dust, dirt and oil etc. A soft cloth with a non-petroleum based solvent (e.g. rubbing alcohol) should be used to clean the surface area.
- Curing should be done at room temperature since temperatures above 80°C can cause Aluminium Composite Panels to deform.

Screen Printing

Aluwedo® Aluminium Composite Panels are perfect for printing with an epoxy base or urethane base two-part type ink/paint. When selecting an ink, confirm its weatherability and adhesion with the ink manufacturer. It is recommended to test the ink adhesion on the surface of the Aluminium Composite Panels before printing.

For printing on Aluminium Composite Panels, observe the following guidelines:

- Remove all dust and dirt on the surface of Aluminium Composite Panels. Oily dirt causes splintering, splitting, or other defects of the paint. It must be completely removed with a soft cloth dipped in alcohol, N-hexane, etc. If storage or drying is not done correctly, the adhesion or other performance may be adversely affected. Therefore, observe the storing conditions of each paint as specified by the manufacturer.
- Since storing in high temperature may cause deformation, ensure the storing temperature is kept below 80°C and store horizontally.



Coating / Printing / Cleaning / Film 2

Cleaning

Aluwedo® Aluminium Composite Panels should be regularly cleaned following the method below. The surface of the panel will commonly accumulate dust, dirt and other airborne particles. In the case of panels used externally, various hydrocarbons from airborne exhausts are also likely to need removal. It is also possible that surfaces could be contaminated with synthetic hydrocarbons from other exhausts such as synthetic grease, oil, hydraulic fluids, lubricants or stains from vegetation like plant or animal matter.

Cleaning Method:

We recommend a 4-step cleaning method:

- 1 Flush panels with water from a hose. 2 Wipe lightly with a soft cloth.
- 3 Use pressure washer.
- 4 Use detergent in a power wash or with a soft cloth for hand wiping and flush with water.

Aluminium Composite Panel UWD-pH test/print life-span Tests have been undertaken to determine the acidity of our panels.

An Insta-check pH pencil (by Micro Essential Laboratory) was used to carry out the tests.

The panel surface was moistened with distilled water and left for 3 minutes. Several lines were drawn with the Insta-Check pH pencil on the wet surface. After 15 seconds the colour of the lines was compared with a pH colour chart. The colours of the lines matched the colour on the chart corresponding to a pH level of 7, which indicates that the

substance is neutral. In conclusion, we can state that the surface of our digital panels is not acidic and that coatings/paints applied will last for years. This means that Aluwedo® Aluminium Composite Panels are suitable, for example, for archival applications.

Material Compatibility

Aluwedo® Aluminium Composite Panel is an extremely durable material that has been designed to withstand significant exposure to environmental conditions. It is unlikely to be compromised by any cleaning process that would conceivably be used on the material.

However, in the interests of maintaining the finish of the material, the prudent user will select products with a pH of 10 or less and which do not contain bleaches, ammonia or caustic ingredients such as sodium hydroxide, potassium hydroxide or sodium metasilicate. It is also recommended that users avoid abrasive materials or tools such as scouring powders, fibre pads or brushes.

Protective Film

- No residue
- Reduce cleaning time
- Elimination of print interference
- Ultra white or transparent surface
- Bright and intense colours
- Vastly improved ink adhesion
- Suitable for indoors and out
- Available reverse side milled
- Digital lacquer covering option

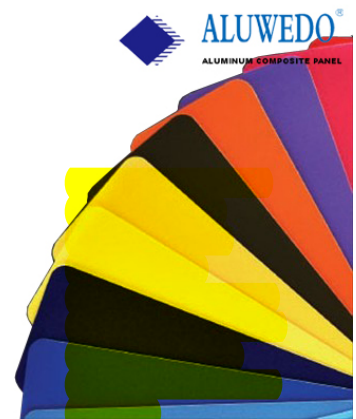

Store the panels in dry and indoor atmosphere, to minimize the natural egradation of the protective film by moisture and direct sunlight during storage.



ALUWEDO®

ALUMINUM COMPOSITE PANEL

Thermal Expansion

All the materials used in construction and sign making will expand when exposed to higher temperatures and shrink when the temperature falls. Each material has its own thermal expansion rate. In the metric system it is measured in mm/m/100°C and shows how many millimetres one meter of material will expand when the temperature changes 100° Celsius.

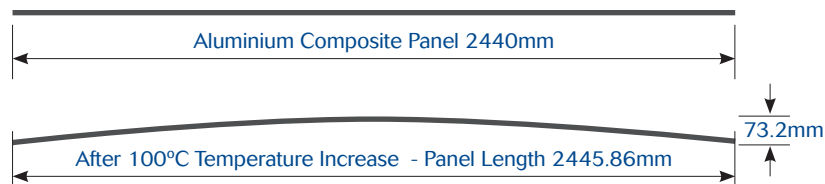

For example, for steel and concrete this rate is around 1.2mm and for PVC it is 5.2mm. When different materials are fixed together it is always necessary to take into account their expansion rates and exposure of those materials to different temperatures.

Aluminium Composite Panels consist of 2 aluminium layers bonded to a polyethylene core. Thermal expansion of Aluwedo® Aluminium Composite Panels is determined by the properties of its aluminium skins. Thermal deflection of aluminium is 2.4 mm/m/100°C.

So a 2440mm long panel with a 100°C temperature fluctuation will expand 5.86mm and its length will become 2445.86m under new temperature conditions. At the same time if 2 edges of the panel are fixed the tension in aluminium skins will lead to panel bowing. Bowing deflection in this case will be 73.2mm.

It is very important to make sure that when installation is done in the conditions where essential temperature fluctuations are expected, fixings shall be designed to allow free thermal expansion of the panels.

Sometimes it may happen that a substrate on which Aluminium Composite Panels are designed to be installed is rigidly fixed without taking thermal expansion into consideration. In this case this substrate can bow and deform causing subsequent bowing of the Aluminium Composite Panel fixed to this substrate. To prevent this substrates on which the Aluminium Composite Panel is going to be installed shall be carefully examined.

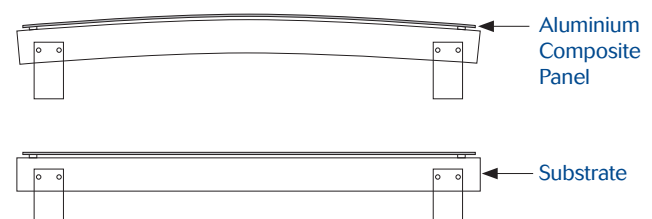



Compensation of Thermal Expansion 1

When installed outdoors under direct sunlight Aluwedo® Aluminium Composite Panel surface temperature can achieve up to 75°C for dark colours. Minimum winter value in Northern countries shall be taken as -35°C. Before any installation it is very important to calculate possible thermal movements and choose the right solution to compensate it taking into account materials of the subframe, temperature during installation, minimum and maximum temperatures in installation area. Compensation of thermal expansion means that Aluminium Composite Panel fixing shall be done to allow some freedom in fixing points so that the panel can independently slide along the subframe when shrinking or expansion of the panel differs from that of the subframe. It allows for the prevention of tension which can lead to panel bending or damage to the fixings.

It is not advice install Aluwedo® Aluminium Composite Panel exterior without grooving and folding. If exposed cutting edge directly in atmosphere, it may caused different materials' thermal movement.

Channel systems and clipping systems allow free movement of the panel alongside the profile. A fixing gap should always be left between panel edge and channel end to allow the panel to expand perpendicularly to the profile.

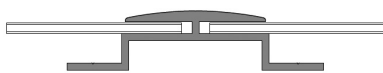

Problems with thermal movements often happen when a panel is fixed to the subframe with rivets or screws. To prevent this special tools shall be used during such installation. When the panel is fixed by rivets, an adjusted step drill and riveting gun with special nozzle shall be used. A step drill cuts a d5.2mm hole in the subframe profile while an 8.5mm or bigger hole is cut in the panel. A special nozzle for riveting guns used to prevent jamming of the rivet head into the panel surface. It fixes the rivet so that a small gap is left between the panel surface and the rivet head to allow free panel movement. Rivets with bigger heads shall also be used. Normally, rivets with 14 or 16mm heads are used.

When screws are used to fix Aluwedo® Aluminium Composite Panels it is possible to use a step drill with the first drill radius at least 1mm smaller than the shaft of the screw. Another option will be to cut holes for the screws in Aluminium Composite Panels prior to installation. The radius of such holes shall be calculated depending on a project to allow free panel movement. Normally at least 8.5mm holes shall be made for 5mm screws. Screws shall be carefully centred in the holes during installation. Screws shall not be fixed tightly and should not jam into the Aluminium Composite Panel. It is recommended to turn the screw 180° to make sure it is not tight. Screws with countersunk heads should not be used.

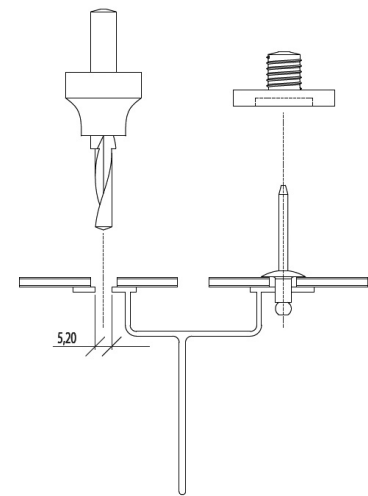



Compensation of Thermal Expansion 2

Sometimes panel length is too big and holes with a bigger diameter can not compensate thermal movement. In such cases oval holes can be cut into the panel. At the same time one or two round holes should be cut to keep the panel in place. A special cutting drill bit can be used to cut such holes.

When a panel is fixed to more than 2 profiles it is recommended to make centre of the panel tightly fixed while sides of the panel shall be left loose.

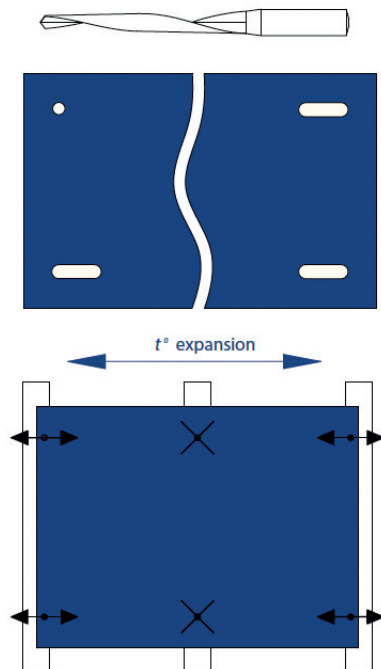

Glue Systems

For projects where essential thermal movements are expected only special flexible glues shall be used. Normally it can be polyurethane based glues with flexibility at break of 300% or more. It is very important to consult a representative of the glue maker to make sure the glue is suitable for the specific project. During installation glue maker's instructions shall be strictly followed. As a general rule glue thickness shall be 3mm at least to have a flexible joint. This can be achieved by using double sided adhesive tapes or other spacers with the necessary height. It is recommended to apply the glue with a special nozzle forming triangle glue beads. Height of such a bead shall be at least two times height of the spacer.

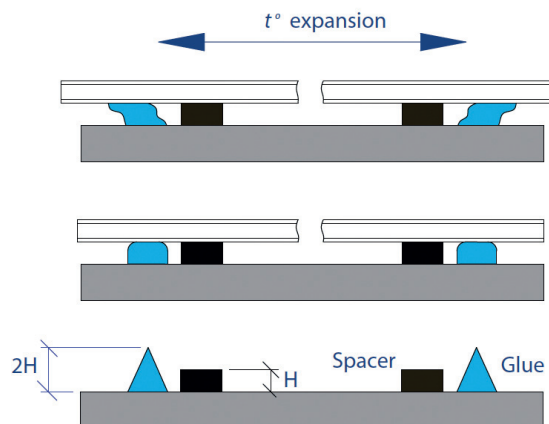



Typical fabrication process

Actual fabrication work of Aluwedo® Aluminium Composite Panel is an integrated work consisting of various machining procedures, assembling and inspection. Below is a typical fabrication process for a standard tray type (rout and return)

1. Check fabrication drawings



Check fabrication drawings and confirm the details.

2. Check raw ALUWEDO

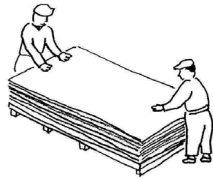

Confirm raw ALUWEDO panels for size, color and quantity with the drawings.

3. Marking on panels



Mark cutting and grooving lines on the back of panels, based on the drawings.

4. Cut

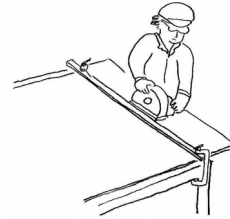

Cut the panel with a hand circular saw, based on marked lines.
8. Cut aluminum extrusions

5. Groove



Adjust the remaining thickness with pre-tests.

6. Corner-notch

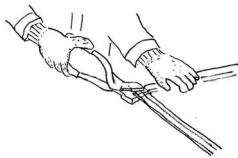

Remove the panel corner with a notching tool or a punching press.

7. Punch hanging holes

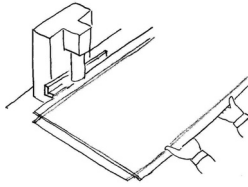

Make hanging holes with a punching press, if necessary.

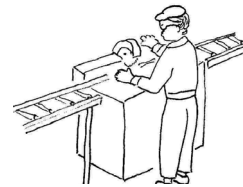

Cut aluminum extrusions, based on the drawings.

9. Fold

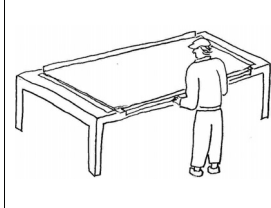

Fold the panel with a folding jig. Check 90-degree after folding.

10. Cut off protective film

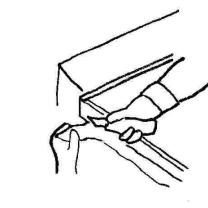

Peel and cut off the protective film edge with a utility knife.

11. Fix corner angle pieces

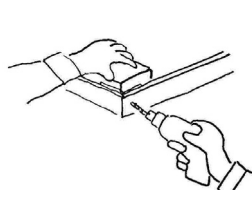

Fix the corner with corner angle piece and rivets.

12. Fix aluminum flange

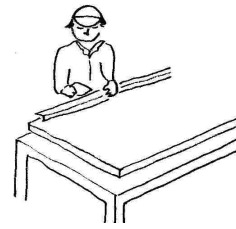

Fix aluminum flange bars with rivets, to complete a tray type panel.

13. Apply sealant on panel corners

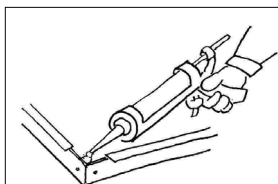

Apply Sealant on corners from back, if necessary

14. Final check

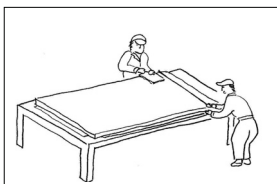

Inspect the completed panels.



ALUWEDO[®]

ALUMINUM COMPOSITE PANEL



SIKO INDUSTRY LIMITED

Tel: 008651256991792

Fax: 008651256991152

Email: info@aluwedo.com

Web: www.aluwedo.com

www.aluminium-composite-panel.cn

All reasonable care has been taken in the compilation of the information contained within this literature. All recommendations on the use of our products are made without guarantee as conditions of use are beyond the control of SIKO INDUSTRY LIMITED. It is the customer's responsibility to ensure that the product is fit for its intended purpose and that the actual conditions of use are suitable.